

# GPS+GSM Combination Antenna JCB013

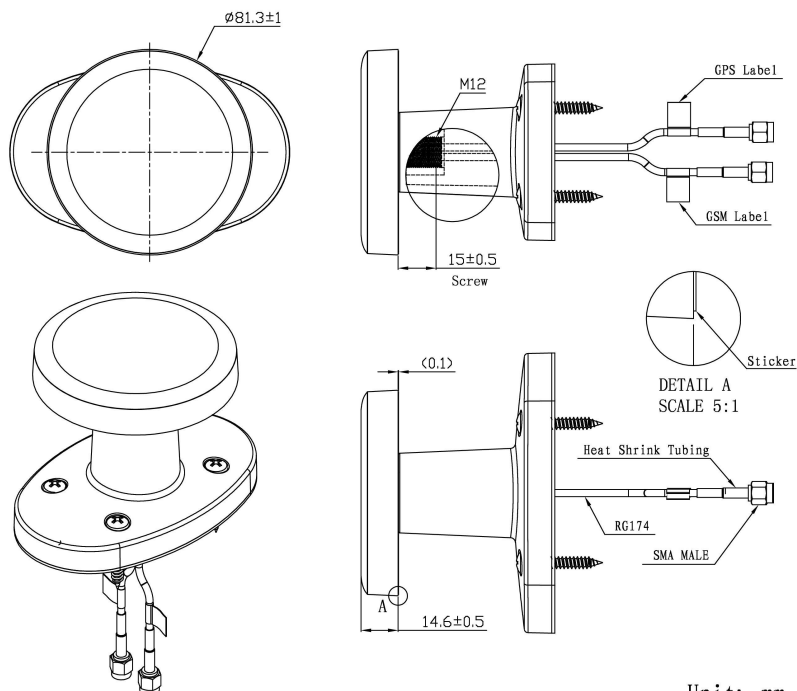

## DIMENSIONS



Unit: mm

JIAXING JINCHANG ELECTRONIC TECHNOLOGY CO.,LTD

Add: 398#, Zhenye Road, South Street, Jiaxing, Zhejiang, China

Http:// www.jinchanggps.com

E-mail: jcgps@vip.163.com

Tel: 86-0573-83692157/83692605/83958637 Fax: 86-0573-83958635

**SPECIFICATIONS**

Item		Specifications	
GPS Antenna	Dielectric Antenna	Center Frequency	1575.42±3MHz
		Band Width	CF±5MHz
		Polarization	RHCP
		Gain	2dBic (Zenith)
		V.S.W.R	<1.5
		Impedance	50Ω
		Axial Ratio	3dB (max)
	LNA	Gain	28±2dB
		Noise Figure	<1.5dB
		V.S.W.R	<2.0
Supply Voltage		2.2~5V DC	
Current Consumption		<15mA	
GSM Antenna		Frequency Range	824~960MHz/1710~2170MHz
		V.S.W.R (min)	<2.5
		Polarization	Linear
		Gain	2dBi
		Impedance	50Ω
Mechanical		Cable	RG174
		Connector	SMA/MCX/FAKRA or others
		Radome Material	ABS
		Mounting Method	Screw
Environmental		Operating Temperature	-40℃~+85℃
		Relative Humidity	Up to 95%
		Ingress Protection	IP65~IP67 (exclude cable outlet)
		Vibration	10 to 55Hz with 1.5mm amplitude 2hours
		Environmentally Friendly	ROHS Compliant

**Radiation Pattern**

GPS Antenna

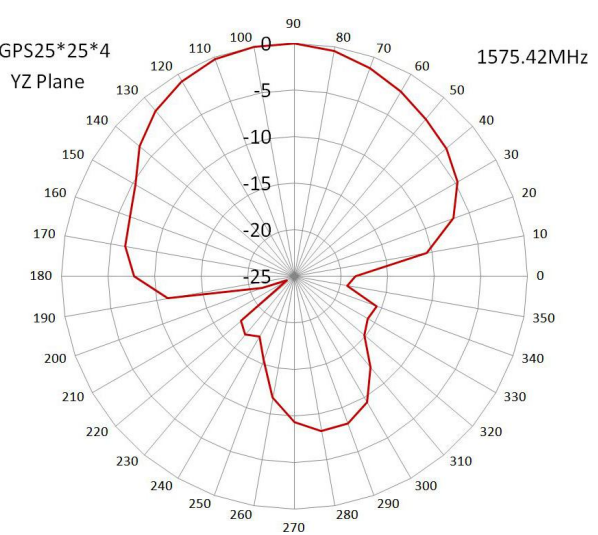
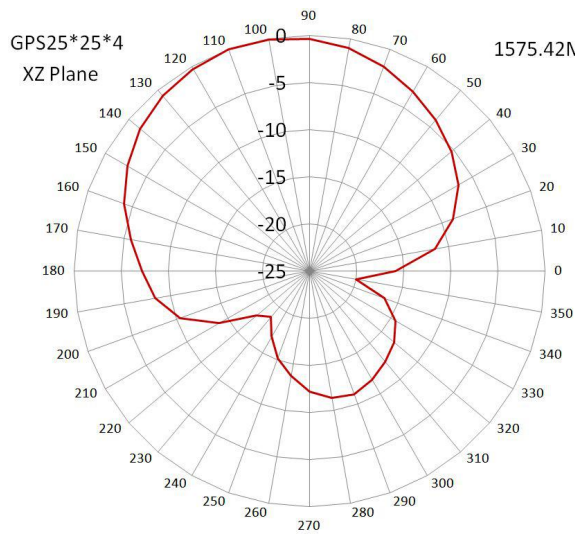
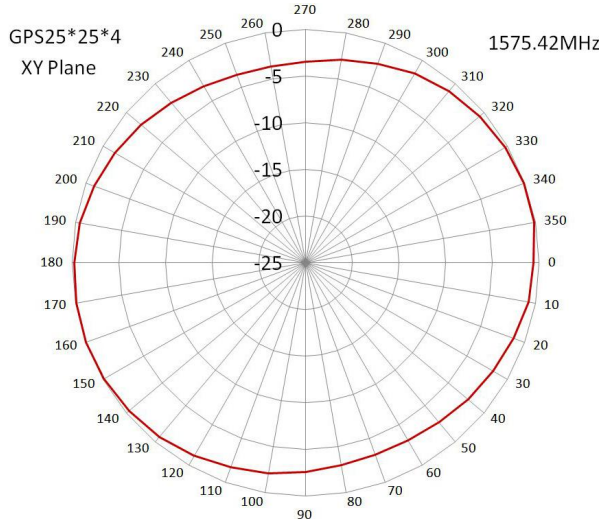

GSM Antenna

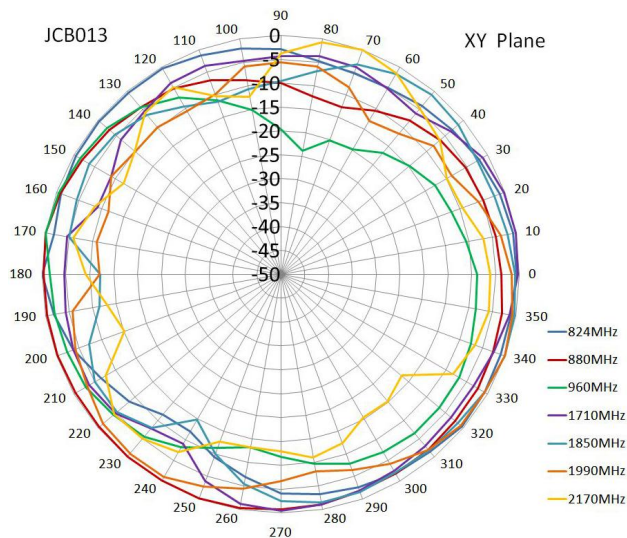



Jinchang Electron Global Service

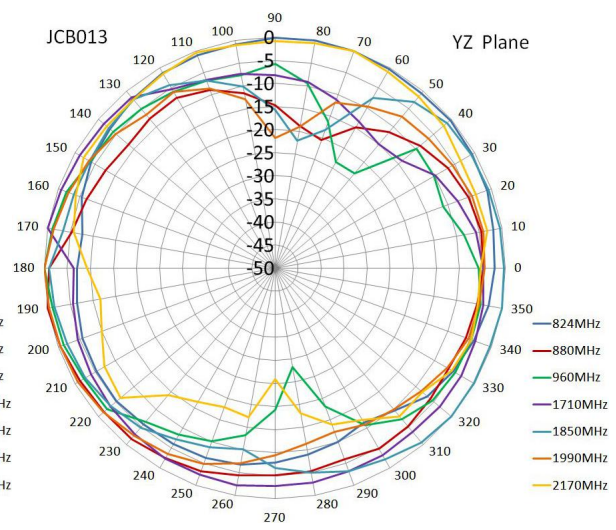
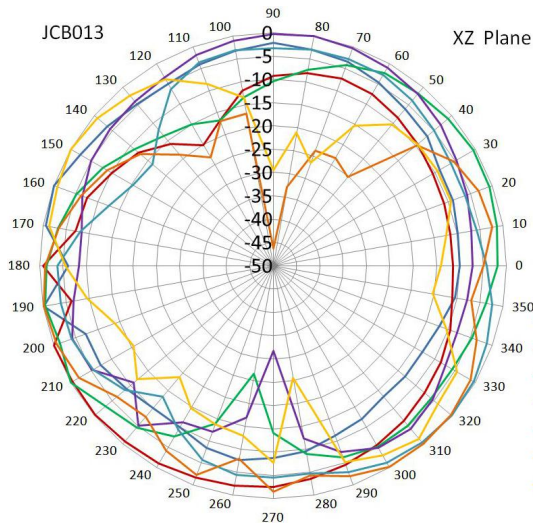

JIAXING JINCHANG ELECTRONIC TECHNOLOGY CO.,LTD

Add: 398#, Zhenye Road, South Street, Jiaxing, Zhejiang, China

Http:// www.jinchanggps.com

E-mail: jcgps@vip.163.com

Tel: 86-0573-83692157/83692605/83958637 Fax: 86-0573-83958635